

Operator's manual **K650 Cut-n-Break**

Please read the operator's manual carefully and make sure you understand the instructions before using the machine.

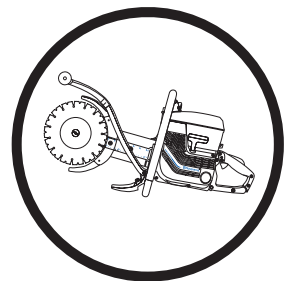

English

KEY TO SYMBOLS

Symbols on the machine:

WARNING! The machine can be a dangerous tool if used incorrectly or carelessly, which can cause serious or fatal injury to the operator or others.



Please read the operator's manual carefully and make sure you understand the instructions before using the machine.



Always wear:

- Protective helmet
- Hearing protection
- Protective goggles or a visor
- Breathing mask



This product is in accordance with applicable EC directives.



WARNING! Dust forms when cutting, this can cause injuries if inhaled. Use an approved breathing mask. Avoid inhaling petrol fumes and exhaust fumes. Always provide for good ventilation.



WARNING! Sparks from the cutting blade can cause fire in combustible materials such as: petrol (gas), wood, dry grass etc.



Choke symbol



Stop symbol

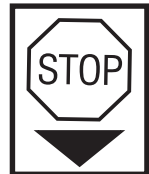

Water cooling must always be used.



Always cut in the correct direction. See safety instructions!

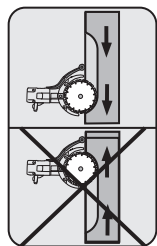

Noise emission to the environment according to the European Community's Directive. The machine's emission is specified in chapter Technical data and on label.



Other symbols/decals on the machine refer to special certification requirements for certain markets.

Symbols in the operator's manual:

Switch off the engine by moving the stop switch to the STOP position before carrying out any checks or maintenance.

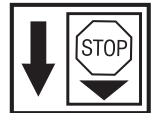

Run position.

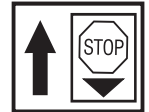

Choke lever in "closed position".

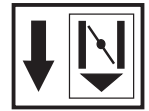

Choke lever in "open position".

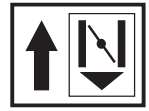

Always wear approved protective gloves.



Regular cleaning is required.

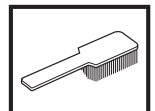

Visual check.



Protective goggles or a visor must be worn.



CONTENTS

Contents

KEY TO SYMBOLS

Symbols on the machine: 2

Symbols in the operator's manual: 2

CONTENTS

Contents 3

WHAT IS WHAT?

What is what on the power cutter? 4

SAFETY INSTRUCTIONS

Steps before using a new power cutter 5

Personal protective equipment 5

General safety precautions 6

Machine's safety equipment 7

Checking, maintaining and servicing the machine's safety equipment 8

Diamond blades 10

General working instructions 11

ASSEMBLY

Assembling the blades 13

Protection for the blades 13

FUEL HANDLING

Fuel 14

Fuelling 14

STARTING AND STOPPING

Before starting 15

MAINTENANCE

Inspecting and adjusting the drive belt 16

Replacing the drive belt 16

Belt pulley and clutch 17

Carburettor 17

Air filter 18

Starter 19

Spark plug 20

Cooling system 21

Muffler 21

General maintenance instructions 21

TECHNICAL DATA

Technical data 22

Cutting equipment 22

EC-declaration of conformity 23

WHAT IS WHAT?

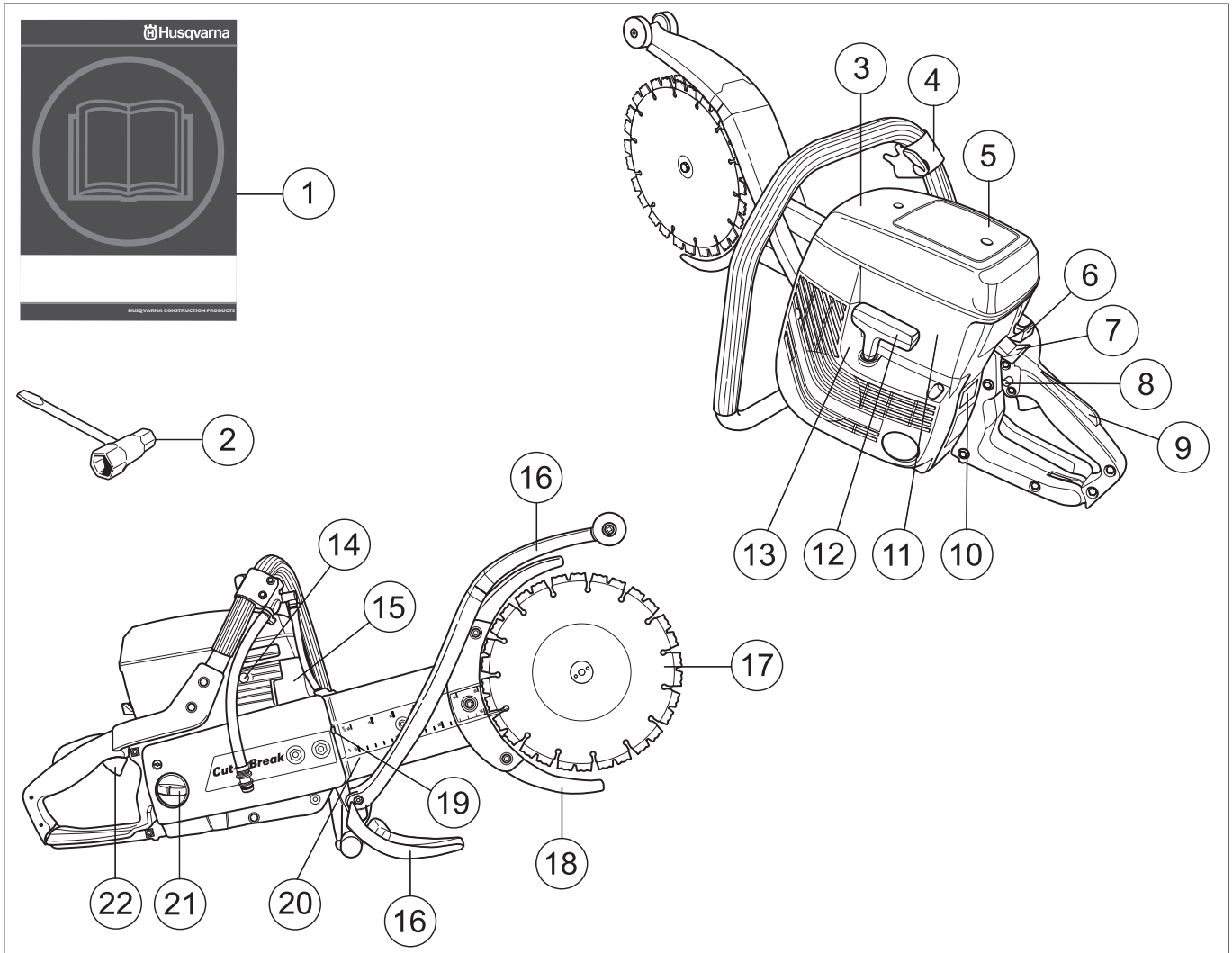

What is what on the power cutter?

- | | |
|------------------------------|------------------------|
| 1 Operator's manual | 12 Starter handle |
| 2 Combination spanner | 13 Starter |
| 3 Air filter cover | 14 Decompression valve |
| 4 Front handle and water tap | 15 Muffler |
| 5 Warning decal | 16 Splash guard |
| 6 Choke | 17 Blades |
| 7 Stop switch | 18 Blade guards |
| 8 Start throttle lock | 19 Belt tensioner |
| 9 Throttle lockout | 20 Cutting arm |
| 10 Rating plate | 21 Fuel tank |
| 11 Cylinder cover | 22 Throttle control |

SAFETY INSTRUCTIONS

Steps before using a new power cutter

- Please read the operator's manual carefully and make sure you understand the instructions before using the machine.
- The machine is only designed for cutting hard materials, such as concrete, brick, masonry as well as cast iron and cement pipes.
- Check the assembly and adjustment of the blades, see the instructions under the heading Assembly of blades.
- Start the engine and check the idling setting, see instructions under the heading Maintenance. When the carburettor is set correctly the blades should be still while idling. Setting of the idle speed is described in the Operator's Manual. Set the correct speed according to these instructions. Do not use the power cutter if the idle speed is not adjusted correctly!
- Let your Husqvarna dealer regularly check the power cutter and make essential adjustments and repairs.



WARNING! Under no circumstances should you modify the original design of the machine without approval from the manufacturer. Always use original spare parts. Unauthorised modifications and/or accessories may lead to serious injury or death to the user or others.



WARNING! Use of products which cut, grind, drill, sand or shape material can generate dust and vapors which may contain harmful chemicals. Know the nature of the material being worked on and wear appropriate dust mask or respirator protection.



WARNING! A power cutter is a dangerous tool if used carelessly or incorrectly and can cause serious, even fatal injuries. It is extremely important that you read and understand the contents of this Operator's Manual.



WARNING! The ignition system of this machine produces an electromagnetic field during operation. This field may under some circumstances interfere with pacemakers. To reduce the risk of serious or fatal injury, we recommend persons with pacemakers to consult their physician and the pacemaker manufacturer before operating this machine.

Husqvarna Construction Products has a policy of continuous product development. Husqvarna reserves the right to modify the design and appearance of products without prior notice and without further obligation introduce design modifications.

All information and all data in the Operator's Manual were applicable at the time the Operator's Manual was sent to print.

Personal protective equipment



WARNING! You must use approved personal protective equipment whenever you use the machine. Personal protective equipment cannot eliminate the risk of injury but it will reduce the degree of injury if an accident does happen. Ask your dealer for help in choosing the right equipment.

- Protective helmet
- Hearing protection
- Protective goggles or a visor

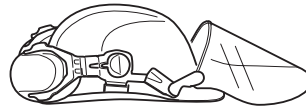

- Breathing mask

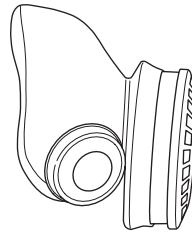

- Heavy-duty, firm grip gloves.

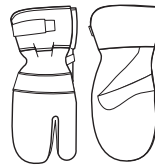

- Tight-fitting, heavy-duty and comfortable clothing that permits full freedom of movement.



- Boots with steel toe-caps and non-slip sole.



- Always have a first aid kit nearby.



SAFETY INSTRUCTIONS

General safety precautions



WARNING! Do not use the power cutter until you have read the entire contents of this Operator's Manual. All servicing, in addition to the points listed in the section "Control, maintenance and service of the power cutter's safety equipment", should be carried out by trained service specialists.

Work area safety

- Keep work area clean and well lit. Cluttered or dark areas invite accidents.
- Never use the machine indoors. Be aware of the dangers of inhaling the engine's exhaust fumes.
- Do not use the machine in bad weather, such as dense fog, rain, strong wind, intense cold, etc. Working in bad weather is tiring and often brings added risks, such as icy ground.
- Never start to work with the power cutter before the working area is clear and you have a firm foothold. Look out for any obstacles with unexpected movement. Ensure when cutting that no material can become loose and fall, causing operating injury. Take great care when working on sloping ground.
- Make sure that no pipes or electrical cables are routed in the area to be cut.
- Look around you:
 - To ensure that people, animals or other things cannot affect your control of the machine.
 - To make sure that none of the above come into contact with the blades.



WARNING! Only use the machine in areas with good ventilation. Neglect can result in serious injury or death.



WARNING! The safety distance for the power cutter is 15 metres. You are responsible to ensure that animals and onlookers are not within the working area. Do not start cutting until the working area is clear and you are standing firmly.

Personal safety

- Wear personal protective equipment. See instructions under the heading Personal protective equipment.
- Never use the machine if you are tired, if you have drunk alcohol, or if you are taking medication that could affect your vision, your judgement or your co-ordination.
- Never allow anyone else to use the machine without first ensuring that they have understood the contents of the operator's manual.
- Dress properly. Do not wear loose clothing or jewellery. Keep your hair, clothing and gloves away from moving parts. Loose clothes, jewellery or long hair can be caught in moving parts.
- Remain at a distance from the blades when the engine is running.
- Always ensure you have a safe and stable working position.



WARNING! Overexposure to vibration can lead to circulatory damage or nerve damage in people who have impaired circulation. Contact your doctor if you experience symptoms of overexposure to vibration. These symptoms include numbness, loss of feeling, tingling, pricking, pain, loss of strength, changes in skin colour or condition. These symptoms normally appear in the fingers, hands or wrists.

Use and care

- A power cutter is designed to cut hard materials, such as masonry. Observe the increased risk of kickback when cutting soft materials. See instructions under the heading How to avoid kickback.
- Never use a machine that is faulty. Carry out the checks, maintenance and service instructions described in this manual. Some maintenance and service measures must be carried out by trained and qualified specialists. See instructions under the heading Maintenance.
- Never use a machine that has been modified in any way from its original specification.
- The guards for the cutting equipment must always be fitted when the machine is running.
- Never move the machine when the cutting equipment is rotating.

Transport and storage

- Store the power cutter in a lockable area so that it is out of reach of children and unauthorised persons.
- Inspect new blades for transport or storage damage.

SAFETY INSTRUCTIONS

Fuel safety



(Refuelling/Fuel mixture/Storage.)



WARNING! Take care when handling fuel. Bear in mind the risk of fire, explosion and inhaling fumes.

- Never refuel the machine while the engine is running.
- Make sure there is plenty of ventilation when refuelling or mixing fuel (petrol and 2-stroke oil).
- Move the machine at least 3 m from the refuelling point before starting it.

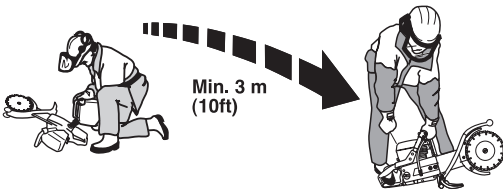

- Never start the machine:
 - If you have spilt fuel on it. Wipe off the spillage and allow remaining fuel to evaporate.
 - If you have spilt fuel on yourself or your clothes, change your clothes. Wash any part of your body that has come in contact with fuel. Use soap and water.
 - If the machine is leaking fuel. Check regularly for leaks from the fuel cap and fuel lines.
- Store and transport the machine and fuel so that there is no risk of any leakage or fumes coming into contact with sparks or naked flames, for example, from electrical machinery, electric motors, electrical relays/switches or boilers.
- Always store fuel in an approved container designed for that purpose.
- When storing the machine for long periods the fuel tank must be emptied. Contact your local petrol station to find out where to dispose of excess fuel.
- Always use a Husqvarna fuel container with an anti-spill valve.



WARNING! Bear in mind the risk of fire, explosion and inhaling fumes. Stop the engine before fuelling. Do not fill so that the fuel runs over. Wipe up all spillage on the ground and machine. If you spill fuel on yourself or your clothes. Change your clothes. Move the machine at least 3 metres away from the refuelling area before starting.

Machine's safety equipment

This section describes the machine's safety equipment, its purpose, and how checks and maintenance should be carried out to ensure that it operates correctly. See the "What is what?" section to locate where this equipment is positioned on your machine.



WARNING! Never use a machine that has faulty safety equipment! Carry out the inspection, maintenance and service routines listed in this section.

Vibration damping system

Your machine is equipped with a vibration damping system that is designed to minimize vibration and make operation easier.

The machine's vibration damping system reduces the transfer of vibration between the engine unit/cutting equipment and the machine's handle unit.

The engine body, including the cutting equipment, is insulated from the handles by vibration damping units.



Stop switch

Use the stop switch to switch off the engine.

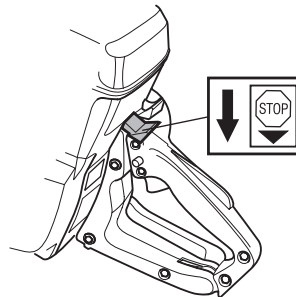

Muffler



WARNING! The muffler gets very hot in use and remains so for a short time afterwards. Do not touch the muffler if it is hot!

The muffler is designed to keep noise levels to a minimum and to direct exhaust fumes away from the user.

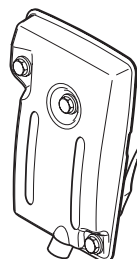

SAFETY INSTRUCTIONS

CAUTION! Never use a machine that has a faulty muffler.



WARNING! The exhaust fumes from the engine are hot and may contain sparks which can start a fire. Never start the machine indoors or near combustible material!

IMPORTANT! For mufflers it is very important that you follow the instructions on checking, maintaining and servicing your machine. See instructions under the heading Checking, maintaining and servicing the machine's safety equipment.



WARNING! The inside of the muffler contain chemicals that may be carcinogenic. Avoid contact with these elements in the event of a damaged muffler.

Throttle lockout

The throttle trigger lock is designed to prevent accidental operation of the throttle. When the lock (A) is pressed in this releases the throttle (B).

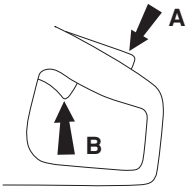

The trigger lock remains pressed in as long as the throttle is pressed. When the grip on the handle is released, both the throttle and throttle lockout return to their original positions. This should be done via two, independent return spring systems. This position means that the throttle is automatically locked to idling and unintentional activation of this is prevented.

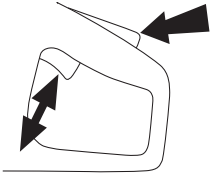

Protection for the blades



WARNING! Always check that the blade guards are correctly fitted before starting the machine.

These guards are fitted above and below the blades and are designed to prevent parts of the blades or cut material from being thrown towards the user.

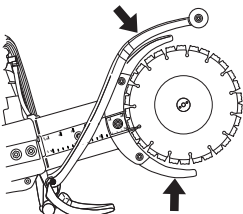

Checking, maintaining and servicing the machine's safety equipment



WARNING! All servicing and repair work on the machine requires special training. This is especially true of the machine's safety equipment. If your machine fails any of the checks described below you must contact your service agent. When you buy any of our products we guarantee the availability of professional repairs and service. If the retailer who sells your machine is not a servicing dealer, ask him for the address of your nearest service agent.

Vibration damping system

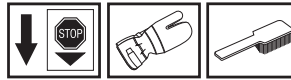

Regularly check the vibration damping units for cracks or deformation.

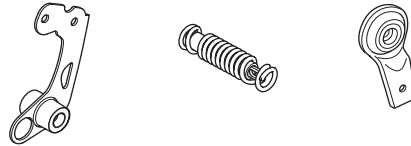

Make sure the vibration damping units are securely attached to the engine unit and handle unit.

Stop switch

Start the engine and make sure the engine stops when you move the stop switch to the stop setting.

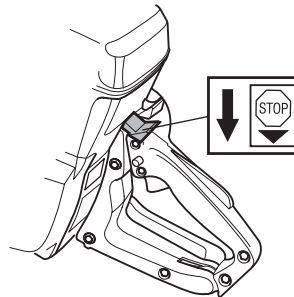

Muffler

Never use a machine that has a faulty muffler.



SAFETY INSTRUCTIONS

Regularly check that the muffler is securely attached to the machine.

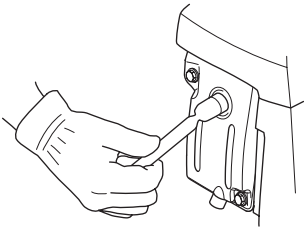

Throttle lockout

- Make sure the throttle control is locked at the idle setting when the throttle lockout is released.

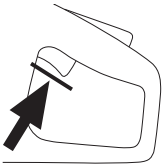

- Press the throttle lockout and make sure it returns to its original position when you release it.

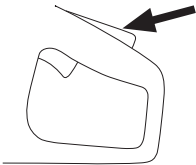

- Check that the throttle control and throttle lockout move freely and that the return springs work properly.

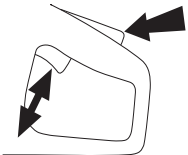

- Start the power cutter and apply full throttle. Release the throttle and check that the blades stop and remain at a standstill. If the blades rotate when the throttle is in the idle position you should check the carburettor's idle adjustment. See instructions under the heading Maintenance.

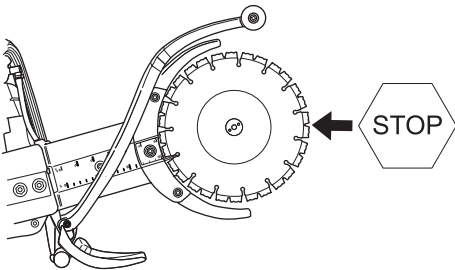

Checking the blade guards

Never use a defective guard or a guard that has not been fitted correctly.

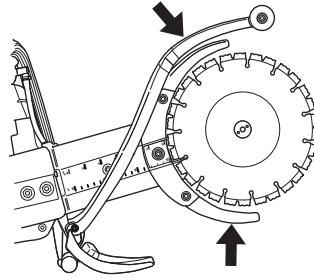

WARNING! Always check that the guards are correctly fitted before starting the machine.

Also check that the blades are fitted correctly and are not damaged in anyway. Damaged blades can cause personal injuries. See instructions under the heading Assembly.

SAFETY INSTRUCTIONS

Diamond blades



WARNING! Blades can break and cause serious injuries to the user.

Never use blades other than original blades designed for the machine.

Never use blades on a material other than the one they are intended for.



WARNING! Cutting plastics with diamond blades can cause kickback when the material melts, due to the heat produced when cutting, and sticks to the blades. Avoid cutting plastics.

General

Only use special diamond blades with integrated belt pulley halves on this machine.

Diamond blades consist of a steel body provided with segments that contain industrial diamonds.

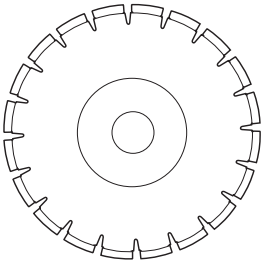

Always use a sharp diamond blade.

Ensure the blades are not cracked or damaged in any other way. Replace blades if necessary.

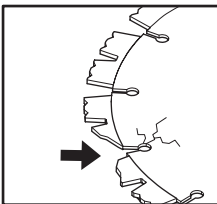

Water cooling

Water cooling must always be used. This cools the blades and increases their life and prevents dust build-up.



WARNING! Cool diamond blades designed for wet cutting continuously with water to prevent heating, which can deform the diamond blade resulting in damage to the machine and personal injury.

Blade vibrations

The blades can become out of true and vibrate if a too high feed pressure is used.

A lower feed pressure can stop the vibration. Otherwise replace the blades. See the instructions under the heading Assembling the blades.

The blades shall be intended for the material to be cut.

Material

Diamond blades are ideal for masonry, reinforced concrete and other composite materials. Diamond blades are not recommended for cutting metal.

Diamond blades are available in several hardness classes. The blades shall be intended for the material to be cut. A "soft" diamond blade has a relatively short service life and large cutting capacity. It is used for hard materials such as granite and hard concrete. A "hard" diamond blade has a longer service life and reduced cutting capacity, and should be used for soft materials such as brick and asphalt.

Sharpening diamond blades

Diamond blades can become dull when the wrong feeding pressure is used or when cutting certain materials such as heavily reinforced concrete. Working with a blunt diamond blade causes overheating, which can result in the diamond segments coming loose.

Sharpen the blade by cutting in a soft material such as sandstone or brick.

High speed handheld machines

Only use special blades with integrated belt pulley halves on this machine.

The blades should be marked with the same or a higher speed than that stated on the machine's rating plate. Never use blades at a lower speed rating than that of the power cutter.

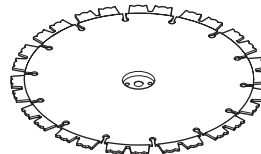

SAFETY INSTRUCTIONS

General working instructions



IMPORTANT! This section describes basic safety directions for using a power cutter. This information is never a substitute for professional skills and experience. If you get into a situation where you feel unsafe, stop and seek expert advice. Contact your dealer, service agent or an experienced power cutter user. Do not attempt any task that you feel unsure of!

Water cooling

Water cooling must always be used. This cools the blades and increases their life and prevents dust build-up.

There is a restrictor in the water hose that reduces the water flow.



At a low water pressure, for example when the water tank is used, the restrictor can be dismantled to give the correct water flow.

CAUTION! It is important not to use a too high water flow without throttling as the belt can then slip.

Cutting technique

- Support the work piece in such a way that it is possible to predict what will happen, and so that the cut remains open while cutting.

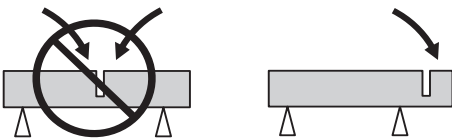

- Always hold the machine in a firm grip with both hands. Hold it so that the thumbs and fingers grip round the handles.
- Check that the blades are not in contact with anything when the machine is started.
- Start cutting with the machine running at maximum speed.
- Start cutting gradually, let the machine work without forcing or pressing the blades. Always cut at maximum speed.
- Cut in the same direction when cutting into an existing cut. Avoid cutting at an angle to the previous cut otherwise there is a risk of the blade jamming or that the machine can "climb in the cut".

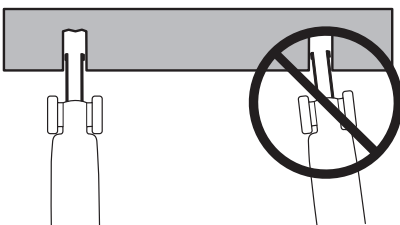

- Always cut from top to bottom. Remove the cutter and use a crowbar to remove the material that remains between the cut (B).

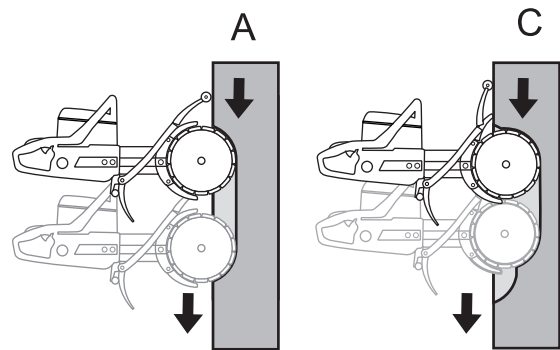

- Follow the same saw cut, but further in the work piece (C), and repeat the work with the crowbar.

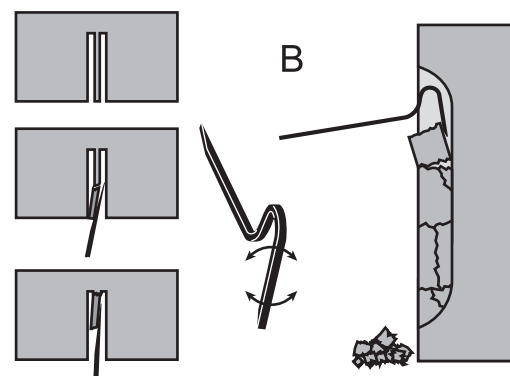

WARNING! When cutting vertically, always cut from the top of the cut and down. Never cut from the bottom of the cut and up. This can cause a kickback and result in personal injury.

- Repeat this working method until the required cutting depth is achieved (D, E).

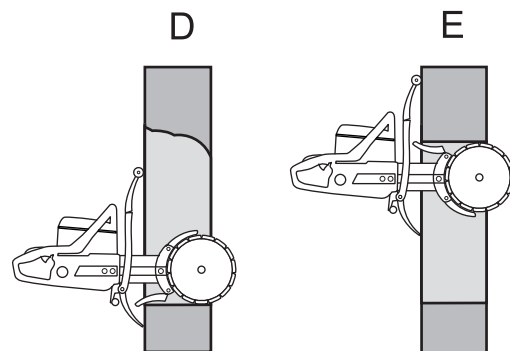

- The blade guards are designed to easily adapt to how deep in the work piece the power cutter is moved.

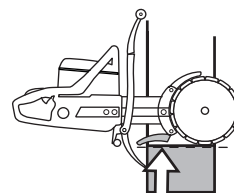

WARNING! Do not pull the power cutter to one side, this can cause the blades to jam or break resulting in personal injury.

SAFETY INSTRUCTIONS

Kickback

Kickback is a sudden, rearward motion of the saw that can occur if the blades are stalled (pinched, jammed, twisted) in the so called kickback zone. Most kickbacks are small and felt as small "jerks" in the front handle. However, kickback can be very powerful. If you are not paying attention or have a poor grip the saw can be thrown all the way back at you.



WARNING! Kickback can be very sudden and violent, throwing the saw back at you. It can cause serious or even fatal injuries. It is vital you understand what causes kickback and how to avoid it using proper cutting technique.

Cause of kickback

Kickback is caused if you are cutting with the kickback zone of the blade for example when cutting "upwards" or towards you.

General rules

- Never cut upwards or towards you so that the kickback zone becomes actively cutting.

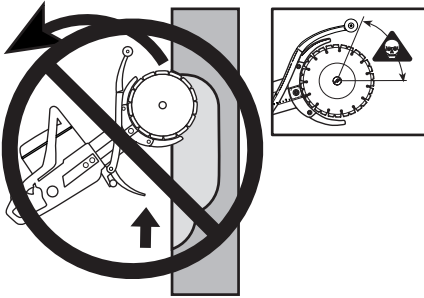

- Always hold the machine in a firm grip with both hands. Hold it so that the thumbs and fingers grip round the handles.
- Keep a good balance and a firm foothold.
- When cutting vertically, always cut from the top of the cut and down.
- Always cut at full throttle.
- Do not cut with the upper quadrant (kickback zone) of the blade. Avoid twisting or pushing the blades sideways in the cut. This can cause kickback.
- Take care when inserting the blade in an existing cut. Make certain that the cut is wide enough and that the blades are not angled in the cut. This can cause kickback.
- Stand at a comfortable distance from the work piece.
- Never cut above shoulder height.
- Never cut from a ladder. Use a platform or scaffold when working at high altitude.
- Be on the alert in case the work piece moves or anything else occurs, which could cause the cut to close and the blades to jam.

Pull in

Pull in occurs when the blades' lower sections suddenly stop or when the cut closes. (To avoid, see the instructions under the heading "Basic rules" and "Jamming/rotation", here below.).

Pinching/rotation

If the cut is pressed together this can lead to jamming. The machine can be pulled down suddenly with a very powerful jerk.

How to avoid pinching

Support the work piece in such a way that the cut remains open during the cutting operation and when the cut is finished.

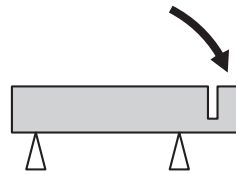

Check the engine speed

Use a revolution counter regularly to check the engine speed at the working temperature, at full throttle and without a load.

ASSEMBLY

Assembling the blades

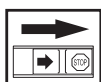

Husqvarna blades are especially manufactured and approved for freehand cutting with the K650 Cut-n-Break. The blades have integrated belt pulley halves and are to be changed in pairs.

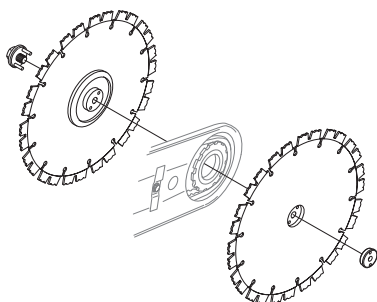

- Loosen the bar nuts, unscrew the clamping screw anticlockwise a few turns and then refit the bar as far as it will go before you dismantle the old blades. This will position the drive belt in a more favourable position with regard to assembling the new blades. **The drive belt is not clamped so easily.**
- Dismantle the old blades by loosening the centre nut. Check the drive belt for wear when the blades are dismantled. When changing the drive belt see the instructions under the heading "Replacing the drive belt".
- Position the blades on each side of the cutting arm. Make sure that the holes for both guide pins in the drive belt halves are aligned so that they correspond with the holes in the washer, and the nut too. Now fit the bolt and washer unit with guide pins.

CAUTION! It is very important that the blades rotate when the nut is tightened. This is to ensure that the belt is not clamped between the integrated drive belt halves on the blades when the blades/drive belt are pulled together with the nut. Ideally this is done alternately, i.e. tighten a little, rotate a little and repeat until the blades are secured.

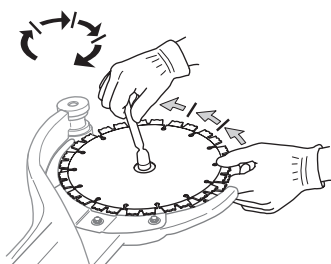

IMPORTANT! Do not forget to tighten the belt and check the belt adjustment before cutting. See the instructions under the heading "Inspecting and adjusting the drive belt".

Protection for the blades

- The guards should always be fitted on the machine. Check that the guards are properly secured and work before starting to cut.

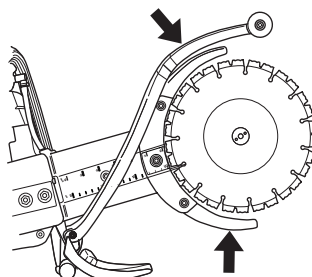

FUEL HANDLING

Fuel

CAUTION! The machine is equipped with a two-stroke engine and must always be run using a mixture of petrol and two-stroke oil. It is important to accurately measure the amount of oil to be mixed to ensure that the correct mixture is obtained. When mixing small amounts of fuel, even small inaccuracies can drastically affect the ratio of the mixture.



WARNING! Always ensure there is adequate ventilation when handling fuel.

Petrol

The lowest octane recommended is 90. If you run the engine on a lower octane than 90 (RON) it can result in knocking. This gives rise to a high engine temperature, which can result in serious engine damage.

Two-stroke oil

- For best results and performance use HUSQVARNA two-stroke engine oil, which is specially formulated for our air-cooled two-stroke engines.
- Never use two-stroke oil intended for water-cooled engines, sometimes referred to as outboard oil (rated TCW).
- Never use oil intended for four-stroke engines.

Mixing ratio

1:50 (2%) with HUSQVARNA two-stroke oil or equivalent.

1:33 (3%) with oils class JASO FB or ISO EGB formulated for air-cooled, two-stroke engines.

Petrol, litre	Two-stroke oil, litre	
	2% (1:50)	3% (1:33)
5	0,10	0,15
10	0,20	0,30
15	0,30	0,45
20	0,40	0,60

Mixing

- Always mix the petrol and oil in a clean container intended for fuel.
- Always start by filling half the amount of the petrol to be used. Then add the entire amount of oil. Mix (shake) the fuel mixture. Add the remaining amount of petrol.

- Mix (shake) the fuel mixture thoroughly before filling the machine's fuel tank.

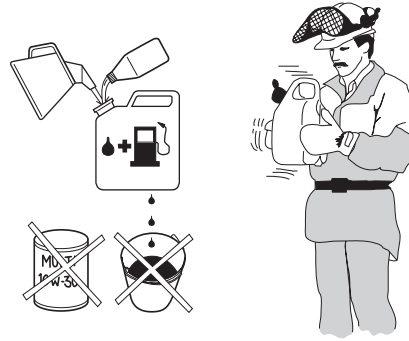

- Do not mix more than one month's supply of fuel at a time.
- If the machine is not used for some time the fuel tank should be emptied and cleaned.

Fuelling



WARNING! Taking the following precautions, will lessen the risk of fire:

Do not smoke and do not place any hot objects in the vicinity of fuel.

Always shut off the engine before refuelling.

When refuelling, open the fuel cap slowly so that any excess pressure is released gently.

Tighten the fuel cap carefully after refuelling.

Always move the machine away from the refuelling area before starting.

- Keep the handle dry and free from oil and fuel.
- Ensure that the fuel is well mixed by shaking the container before filling the tank.
- Always exercise care when refilling the fuel. Move the machine at least three metres from the fuelling area before it is started. Check that the fuel cap is tightened correctly.

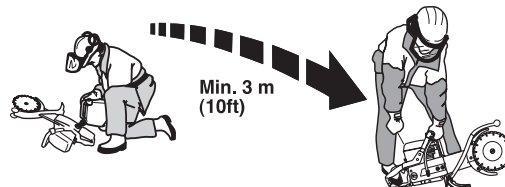

- Clean around the fuel cap. Clean the fuel and oil tank regularly. The fuel filter should be changed at least once a year. Contamination in the tanks causes malfunction.

STARTING AND STOPPING

Before starting



WARNING! Note the following before starting:

Do not start the power cutter without the clutch cover fitted. Otherwise the clutch could come loose and cause personal injuries.

Always move the machine away from the refuelling area before starting.

Ensure that you and the machine have a good working stance and that the blades can rotate freely.

Keep people and animals well away from the working area.

Water connector

Connect the water hose to the water supply. The water flow is regulated using the water tap.

Starting a cold engine

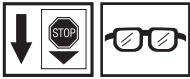

Decompression valve: Press in the valve to reduce the pressure in the cylinder, this is to assist starting the power cutter. The decompression valve (A) should always be used when starting. The valve automatically returns to its initial position when the machine starts.

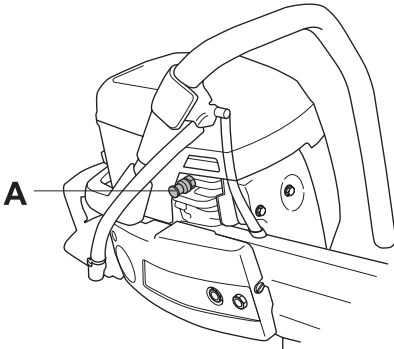

Start throttle lock: Press in the throttle trigger lock, throttle control and then the start throttle lock (B). Release the throttle control and it is locked in the half throttle position. The lock releases when the throttle control is pressed in fully.

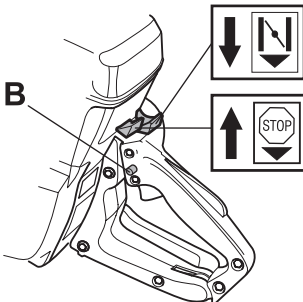

Ignition: Set the stop switch to the start position.

Choke: Pull the choke control fully out.

Starting a warm engine

Use the same starting procedure as for a cold engine but without setting the choke control in the choke position.

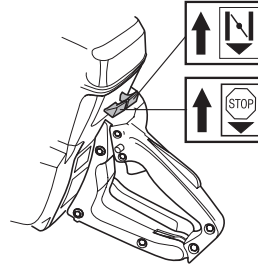

Starting



WARNING! The blades rotate when the engine is started. Make sure they can rotate freely.

Grip the front handle with your left hand. Put your right foot on the lower section of the rear handle pressing the machine against the ground. **Never twist the starter cord around your hand.**

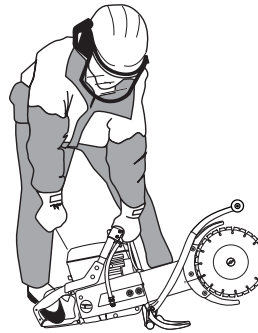

Grip the starter handle, slowly pull out the cord with your right hand until you feel some resistance (the starter pawls grip), now quickly and powerfully pull the cord.

CAUTION! Do not pull the starter cord all the way out and do not let go of the starter handle when the cord is fully extended. This can damage the machine.

When the engine starts, quickly apply full throttle to automatically disengage fast idle.

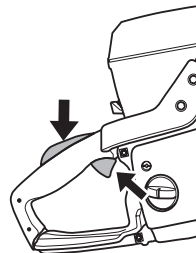

Stopping

The engine is stopped by switching the ignition off using the stop switch.

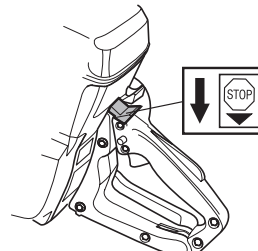

MAINTENANCE

Inspecting and adjusting the drive belt



- The drive belt is fully enclosed and well-protected from dust, dirt and mechanical damage when cutting.
- Check the drive belt adjustment by feeling with your fingers as illustrated. A correctly adjusted drive belt should have about 5 mm of movement.

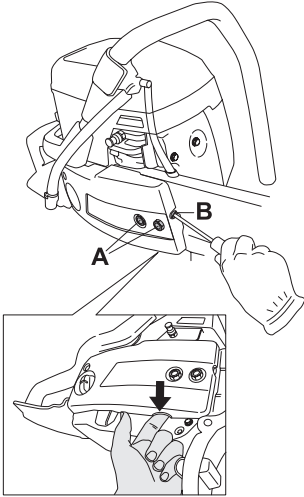

- To adjust the drive belt, loosen both the screws (A) holding the bar one turn anticlockwise.
- Turn the adjuster screw (B) clockwise at the same time as you feel with your fingers how the drive belt is adjusted. When there is about 5 mm of movement on the drive belt this is adjusted correctly and you can then tighten both screws holding the bar.

IMPORTANT! A new drive belt must be readjusted after one or two tanks of fuel have been used.

Replacing the drive belt



- Release the belt tension.

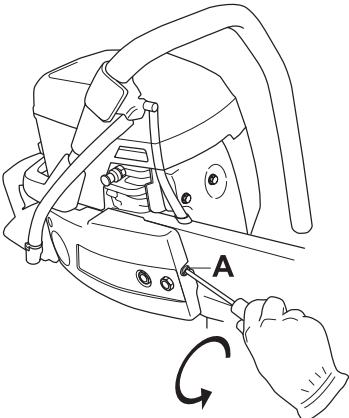

- Remove the blades.

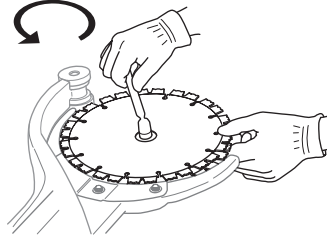

- Remove the clutch cover by loosening the screws A and B.

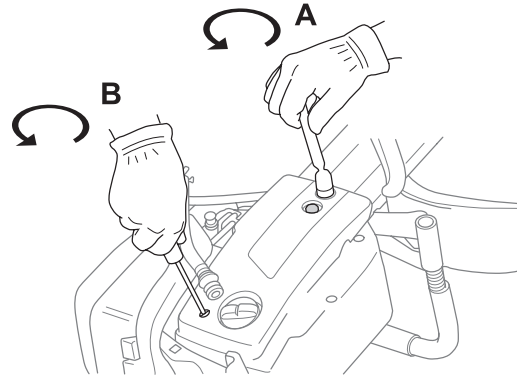

- Remove the drive belt from the nose of the cutting arm (C).

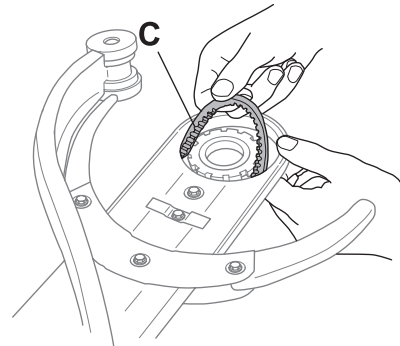

- Loosen water hose (E). Slide back the bar and remove the drive belt around the clutch (D).

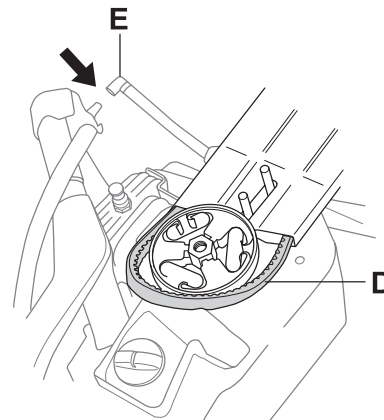

MAINTENANCE

- Pull off the cutting arm by pulling it straight forwards, as illustrated.

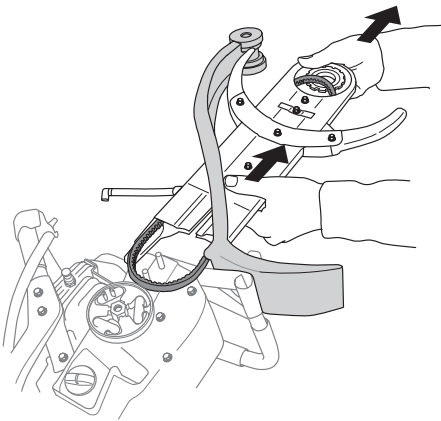

- Remove the complete drive belt (D).
- Loosen the six screws (F) holding the guards on the cutting arm.

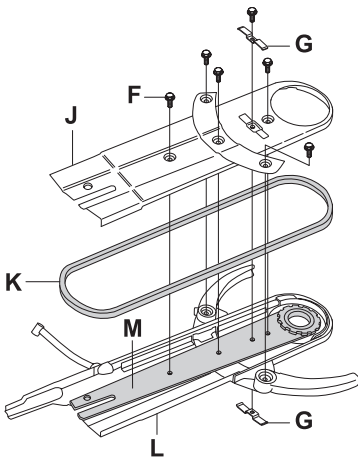

- Fit the new drive belt (K).
- Refit the guards and belt cover.
- The bar (M) must be positioned on plate (L) so that the holes in the plate align with the holes in the bar.
- The edges of the plate (J) must lie inside the edges of the plate (L).
- Tight the six screws (F) and check/adjust the drive belt's (K) tension. See the instructions under the heading "Inspecting and adjusting the drive belt".
- The movement limiters (G) are fitted last. Clamp together the plates as illustrated.

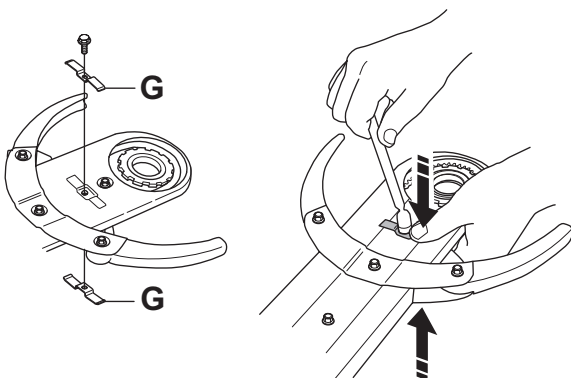

- Refit the blades and tighten the nut. See instructions under Heading "Assembling the blades".

CAUTION! Make sure that the belt adjuster screw bottoms and that the bar is fully screwed back so that the belt cover fits correctly.

Belt pulley and clutch

Never start the engine when the belt pulley and clutch have been removed.

Carburettor

Your Husqvarna product has been designed and manufactured to specifications that reduce harmful emissions.

Function

The carburettor governs the engine speed via the throttle. Air and fuel are mixed in the carburettor.



WARNING! Do not start the machine without the cutting arm or cutting head fitted. Otherwise the clutch could come loose and cause personal injuries.

Needles

The carburettor is equipped with fixed needles to ensure the machine always receives the correct mixture of fuel and air. When the engine lacks power or accelerates poorly, do the following:

- Check the air filter and replace if necessary.
- When this does not help, contact an authorised service workshop.

Fine adjustment of the idle speed T

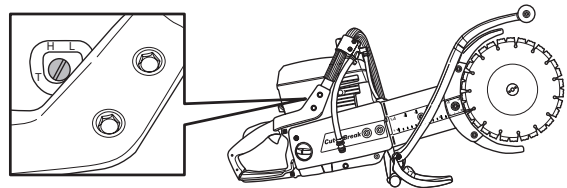

Adjust the idle speed using the T screw. If adjustment is necessary, first turn the idle screw clockwise until the blades start to rotate. Now turn the screw anticlockwise until the blades stop rotating. A correctly adjusted idle speed is set when the engine accelerates without hesitation.

Rec. idle speed: 2500 rpm



WARNING! If the idle speed cannot be adjusted so that the cutting attachment stops, contact your dealer/service workshop. Do not use the machine until it has been correctly adjusted or repaired.

MAINTENANCE

Air filter



Air filters must be regularly cleaned to remove dust and dirt in order to avoid:

- Carburettor malfunctions
- Starting problems
- Less power
- Unnecessary wear to engine parts.
- Excessive fuel consumption.

The air filter system consists of an oiled foam plastic filter (1) and a paper filter (2):

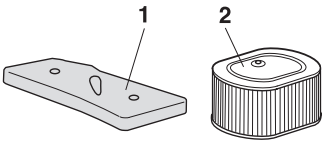

- The foam plastic filter is easily accessible under the filter cover A. This filter should be checked weekly and replaced if necessary. In order to obtain a good filtering effect, the filter must be replaced regularly or cleaned and oiled. A special HUSQVARNA oil has been produced for this purpose.

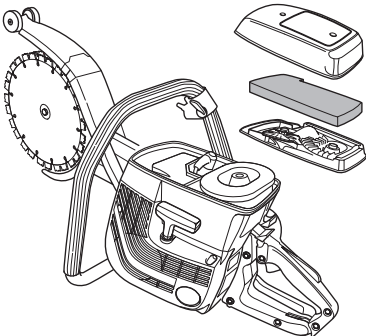

- Remove the foam plastic filter. Wash the filter well in tepid soapy water. After cleaning, rinse the filter well in clean water. Squeeze out and allow the filter to dry. NOTE! High pressure compressed air can damage the foam.



- Oil the foam plastic filter well. It is extremely important that the entire filter is saturated with oil.
- Put the filter in a plastic bag and pour the filter oil over it. Knead the plastic bag to distribute the oil. Squeeze the excess oil out of the filter inside the plastic bag and pour

off the excess before fitting the filter to the machine. Never use common engine oil. This would drain through the filter quite quickly and collect in the bottom.

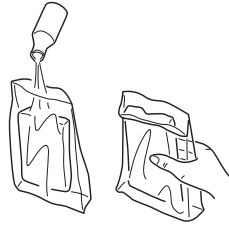

- A foam plastic filter that has been washed many times wears. Replace with a new filter if it is not elastic and seals well against the filter cover.
- The paper filter is accessible under cover B. This filter must be replaced/cleaned when the engine's power drops or after one-two weeks. Note that the filter must not be washed.

An air filter that has been in use for a long time cannot be cleaned completely. The filter must therefore be replaced with a new one at regular intervals. **A damaged air filter must always be replaced.**

IMPORTANT! Poor maintenance of the air filter will cause carbon build-up on the spark plug and abnormal wear to engine parts.

Fuel filter

- The fuel filter sits inside the fuel tank.
- The fuel tank must be protected from contamination when filling. This reduces the risk of operating disturbances caused by blockage of the fuel filter located inside the tank.
- The filter cannot be cleaned but must be replaced with a new filter when it is clogged. **The filter should be changed at least once per year.**

Water tap

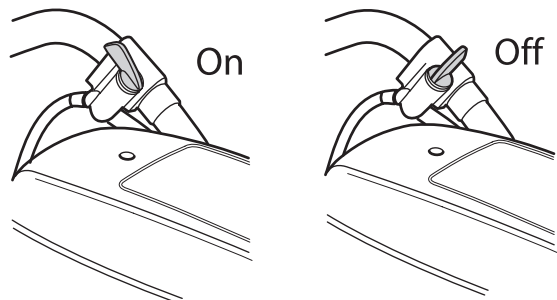

Water filter

Check and clean the restrictor if necessary.



MAINTENANCE

Starter



WARNING! When the recoil spring is wound up in the starter housing it is under tension and can, if handled carelessly, pop out and cause personal injury.

Always be careful when changing the recoil spring or the starter cord. Always wear protective goggles.

Changing a broken or worn starter cord



- Loosen the filter and cylinder cover.
- Loosen the screws that hold the starter against the crankcase and remove the starter.

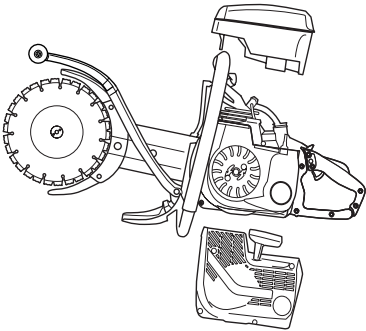

- Pull out the cord approx. 30 cm and hook it into the notch in the rim of the pulley. Release the recoil spring by letting the pulley rotate slowly backwards.

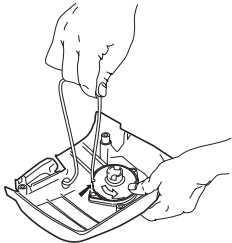

- Remove any remnants of the old starter cord and check that the return spring works. Insert the new starter cord through the hole in the starter housing and in the cord pulley.

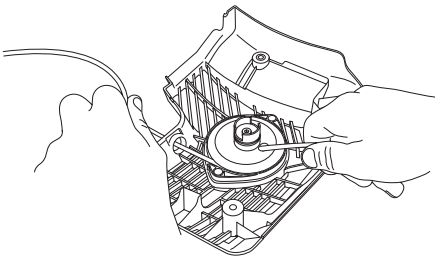

- Secure the starter cord around the cord pulley as illustrated. Tighten the fastening well and ensure that the free end is as short as possible. Secure the end of the starter cord in the starter handle.

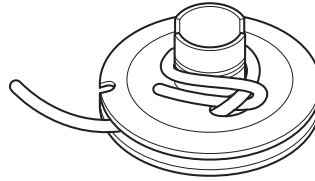

- Guide the cord through the cut-out in the periphery of the pulley and wind the cord 3 times clockwise around the centre of the starter pulley.

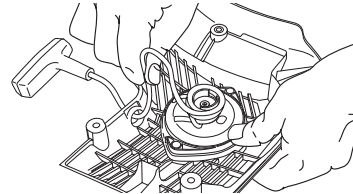

- Now pull the starter handle and in doing so tension the spring. Repeat the procedure once more, but this time with four turns.
- Note that the starter handle is drawn to its correct home position after tensioning the spring.
- Check that the spring is not drawn to its end position by pulling out the starter line fully. Slow the starter pulley with your thumb and check that you can turn the pulley at least a further half turn.

Tensioning the recoil spring

- Hook the starter cord in the notch in the pulley and turn the starter pulley about 2 turns clockwise.

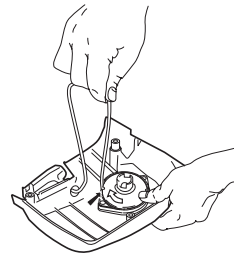

CAUTION! Check that the pulley can be turned at least a further 1/2 turn when the starter cord is pulled all the way out.

MAINTENANCE

Changing a broken recoil spring



- Undo the bolt in the centre of the pulley and remove the pulley.
- Bear in mind that the return spring lies tensioned in the starter housing.
- Loosen the bolts holding the spring cassette.

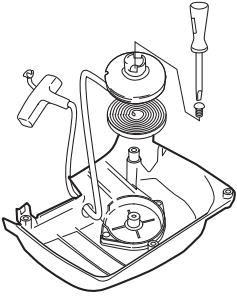

- Remove the recoil spring by turning the starter over and loosen the hooks, with the help of a screwdriver. The hooks hold the return spring assembly on the starter.
- Lubricate the recoil spring with light oil. Fit the pulley and tension the recoil spring.

Fitting the starter

- To fit the starter, first pull out the starter cord and place the starter in position against the crankcase. Then slowly release the starter cord so that the pulley engages with the pawls.

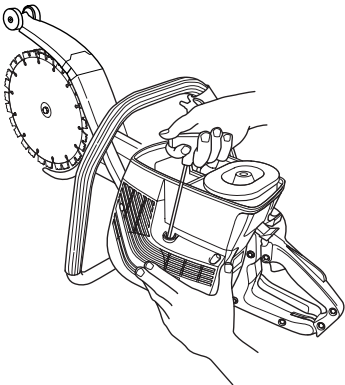

- Assemble the starter and tighten the screws.
- Fit the cylinder cover and filter cover.

Spark plug



The spark plug condition is influenced by:

- Incorrect carburettor adjustment.
- Wrong fuel mixture (too much oil).
- A dirty air filter.

These factors cause deposits on the spark plug electrodes, which may result in operating problems and starting difficulties.

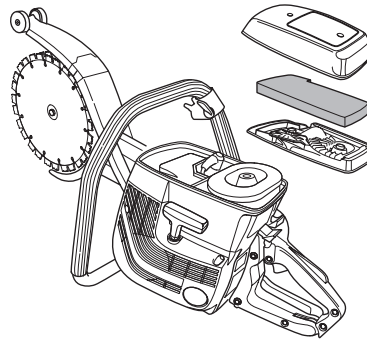

- If the machine is low on power, difficult to start or runs poorly at idle speed: always check the spark plug first before taking any further action. If the spark plug is dirty, clean it and check that the electrode gap is 0.5 mm. The spark plug should be replaced after about a month in operation or earlier if necessary.

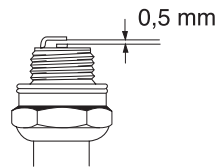

CAUTION! Always use the recommended spark plug type! Use of the wrong spark plug can damage the piston/cylinder.

MAINTENANCE

Cooling system

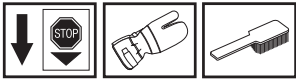

To keep the working temperature as low as possible the machine is equipped with a cooling system.

The cooling system consists of:

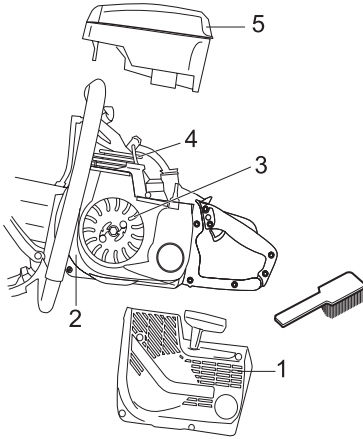

- 1 Air intake on the starter.
- 2 Air guide plate.
- 3 Fins on the flywheel.
- 4 Cooling fins on the cylinder.
- 5 Cylinder cover (directs cold air over the cylinder).

Clean the cooling system with a brush once a week, more often in demanding conditions. A dirty or blocked cooling system results in the machine overheating which causes damage to the piston and cylinder.

Muffler



The muffler is designed to reduce the noise level and to direct the exhaust gases away from the operator. The exhaust gases are hot and can contain sparks, which may cause fire if directed against dry and combustible material.

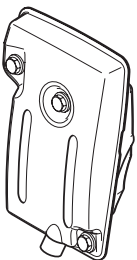

Never use a machine with a defective muffler.

General maintenance instructions

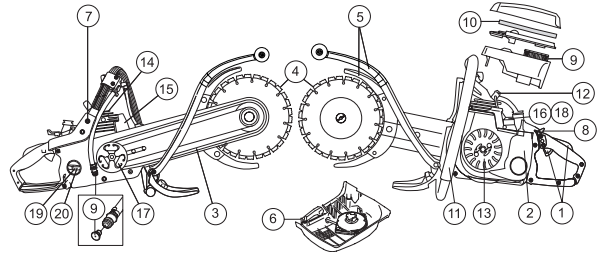

Below you will find some general maintenance instructions. If you have more questions, contact your service agent.

Daily maintenance

- 1 Check that the components of the throttle control work smoothly (throttle control and throttle trigger lock).
- 2 Clean the outside of the machine.
- 3 Check the tension of the drive belt.
- 4 Check the condition of the blades and the drive gear.
- 5 Check the condition of the blade guards.
- 6 Check the starter and starter cord and clean the outside of the starter unit's air intake.
- 7 Check that nuts and screws are tight.
- 8 Check that the stop switch works correctly.
- 9 Check the function of the restrictor.

Weekly maintenance

- 10 Check the condition of the air filter.
- 11 Check that the handles and vibration damping elements are not damaged.
- 12 Clean the spark plug. Check that the electrode gap is 0.5 mm.
- 13 Clean the fins on the flywheel. Check the starter and the recoil spring.
- 14 Clean the cooling fins on the cylinder.
- 15 Check that the muffler is securely attached and not damaged.
- 16 Check the operation of the carburettor.

Monthly maintenance

- 17 Check the clutch centre, drive gear and clutch spring for wear.
- 18 Clean the outside of the carburettor.
- 19 Check the fuel filter and the fuel hose. Replace if necessary.
- 20 Clean the inside of the fuel tank.

TECHNICAL DATA

Technical data

	K650 Cut-n-break
Engine	
Cylinder displacement, cm ³	71
Cylinder bore, mm	50
Stroke, mm	36
Idle speed, rpm	2500
Recommended max. fast idle speed, rpm	9750 (+/- 250)
Power, kW	3,5
Ignition system	
Manufacturer of ignition system	EM
Spark plug	Champion RCJ 6Y/ NGK BPMR 7A
Electrode gap, mm	0,5
Fuel and lubrication system	
Manufacturer of carburettor	Tillotson
Carburettor type	W CAT: 5,7
Fuel tank capacity, litre	0,7
Weight	
Weight, including water kit, without fuel and cutting attachment, kg	8,9
Weight, including water kit with fuel and with cutting attachment, kg	10,3
Noise emissions	
(see note 1)	
Sound power level, measured dB(A)	115
Sound power level, guaranteed L _{WA} dB(A)	116
Sound levels	
(see note 2)	
Equivalent sound pressure level at the operator's ear, measured according to EN 1454 dB(A)	100
Vibration levels	
Handle vibrations measured according to ISO 19432	
Front handle, equivalent value, m/s ²	3,2
Rear handle, equivalent value, m/s ²	5,7

Note 1: Noise emissions in the environment measured as sound power (L_{WA}) in conformity with EC directive 2000/14/EC.

Note 2: Equivalent sound pressure level is calculated as the time-weighted energy total for sound pressure levels under various working conditions with the following time distribution: 1/2 idling and 1/2 max speed.

Cutting equipment

Cutting blade	Gear ratio	Max. peripheral speed, m/s	Max cutting depth
9"	48/79	80	400 mm

Max. blade speed, rpm

6200



TECHNICAL DATA

EC-declaration of conformity

(Applies to Europe only)

Husqvarna Construction Products, SE-433 81 Partille, Sweden, tel: +46-31-949000, declares under sole responsibility that the power cutter **K650 Cut-n-Break** from 2006's serial numbers and onwards (the year is clearly stated in plain text on the rating plate with subsequent serial number), complies with the requirements of the COUNCIL'S DIRECTIVES:

- of June 22, 1998 "relating to machinery" **98/37/EC**, annex IIA.
- of December 15, 2004 "relating to electromagnetic compatibility" **2004/108/EC**.
- of May 8, 2000 "relating to the noise emissions in the environment" **2000/14/EC**. Conformity assessment according to Annex V.

For information relating to noise emissions, see the chapter Technical data.

The following standards have been applied: **EN ISO 12100:2003, EN ISO 55012:2002, EN 1454, ISO 19432**

SMP Svensk Maskinprovning AB, Fyrisborgsgatan 3, SE-754 50 Uppsala, Sweden, has carried out voluntary type approval concerning the directive 2000/14/EC on behalf of Husqvarna AB. The certificate has the number: **01/169/002**

Partille 2 may 2006



Ove Donnerdal, Development Manager

1151266-26



2008-07-07